



Titan Dynamics

[Titan Dynamics Webpage](#)

[Visit our Facebook page](#)

[Join our Discord server](#)

Titan Dynamics – Micro Trooper

<https://www.titandynamics.org/3dhanger/p/titan-micro-trooper>

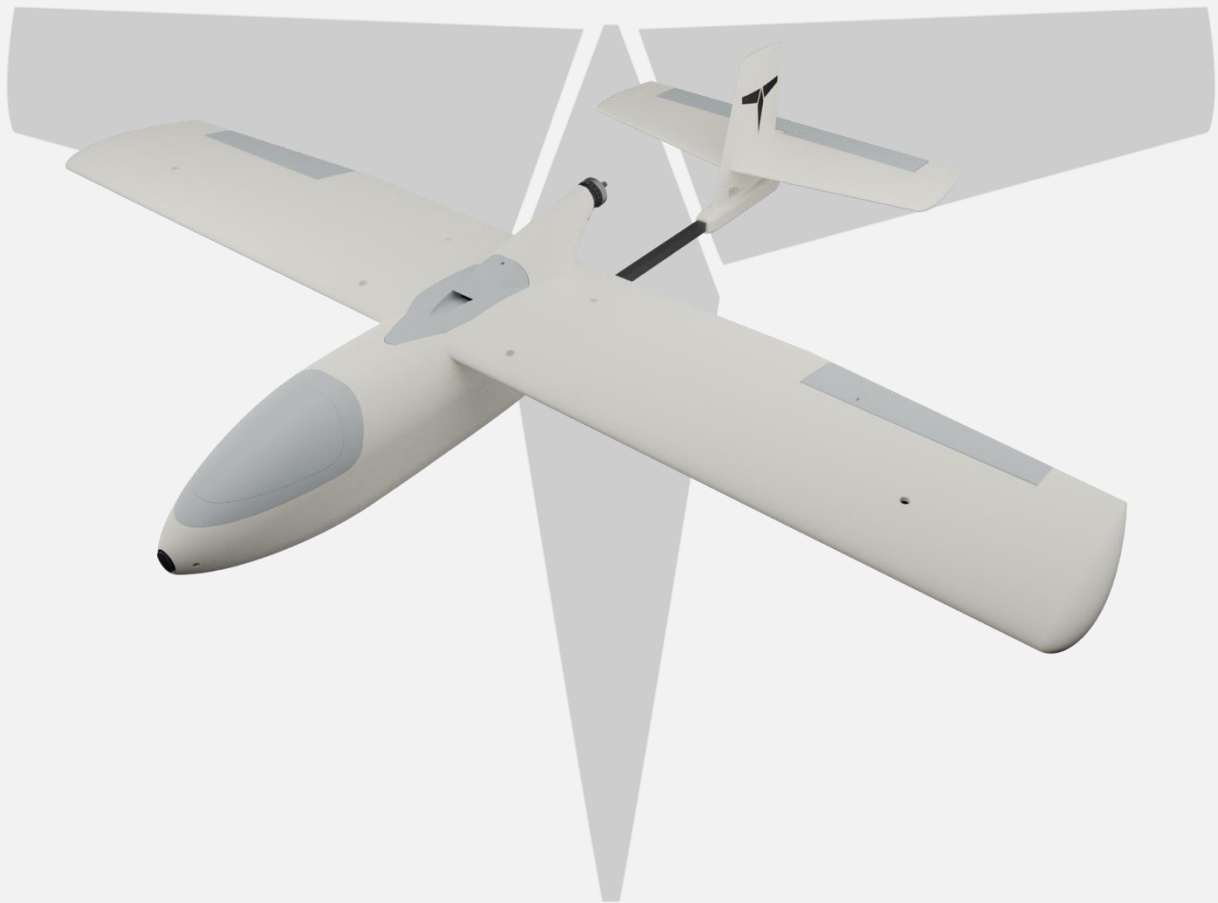

Build & User Manual

Revision 1.1



Contents

Section 1: Model Information	3
Section 2: Model Specifications & Performance.....	4
Section 3: Required Build Materials	5
Section 4: 3D printing	6
4.1: Things to know before you start printing.	6
4.2: Part Orientation	7
4.3: Tuning "hole horizontal expansion"	9
4.4: Bed Adhesion and warping	9
Section 5: Assembly of 3D Printed Parts.....	11
Section 6: Final Setup & Tuning Tips	16
Section 7: Additional Images.....	17



Section 1: Model Information

The Titan Micro Trooper is a 1 meter wingspan FPV platform for fun acrobatic or long range flying. Great effort went into packing as many features into it as possible, many of which are inherited from the full-size Trooper, such as: A double decker FPV canopy for accommodating pan/tilt setups, fully supportless printing, plenty of room in the fuselage, wing bays for mounting VTX/RX with ample antenna separation and removable wings. With an excellent recorded efficiency of 0.85wh/km, Micro Trooper can fly for up to 2 hours and 170km with a 4S2P 10000mah Li-Ion. At the same time, with a small 4-6S Lipo, Micro Trooper can also be a lively acrobatic beast!





Section 2: Model Specifications & Performance

General Stats:

- Wingspan: 1040mm
- Wing area: 2114cm²
- Maximum take-off Weight: 2kg
- Efficiency: 0.85 Wh/km
- Cruise speed: 65-75kph
- Recommended prop diameter: 6-8 inches

Aerodynamic Properties:

- Root airfoil: NACA 3412
- Tip airfoil: NACA 2412
- Root chord: 153mm
- Tip chord: 104mm
- Average Chord: 170mm
- Root incidence: 2°
- Tip incidence: 0°
- Aspect ratio: 4.72
- Max L/D: 25.5
- Dihedral: 0°
- Sweep: -6° at trailing edge of tip





Section 3: Required Build Materials

Spars needed:

- (1) 8 OD x 6 ID x 500mm (front main wing spar)
- (1) 4x500mm solid (rear main wing spar)
- (2) 4x400mm solid (inside wing)
- (2) 3x200mm solid (aileron hinge)
- (2) 3x400mm solid (hstab + elevator hinge)
- (1) 10 OD x 8 ID x 500mm square (tail boom – must be glued to fuselage and tail)

Recommended motor & prop:

- 16mm mounting pattern
- Tmotor F40 or V2208 or similar
- 6-8 inch propeller (ideally 7x4/5/6)

Recommended electronics:

- TBS crossfire / ELRS / Dragonlink
- 5.8ghz / 1.2ghz analog or digital (19x19 camera)
- Matek F405-WTE flight controller or similar
- Matek M8Q-5883 GPS/Compass or similar
- 35a BLHeli ESC
- (3) Emax ES08MAII servos
- Battery: Anything from a 5000mah Lipo to a 10,000mah 4S Li-Ion

Misc:

- Polymaker Polylite prefoamed LWPLA
- Polycarbonate or other high-temp filament for the motor mount
- Medium CA glue
- 210x210x250 minimum size print bed (Prusa Mk3)
- Control horns ([this one](#)).
- M3 threaded inserts (max 6mm height)
- M3 bolts of various sizes
- 6x3mm magnets



Section 4: 3D printing

4.1: Things to know before you start printing.

1. Titan Dynamics strongly recommends using Polymaker Polylite prefoamed LWPLA for the best results. This filament is much easier to tune your printer for and has less stringing than active foaming filaments. If you aren't able to purchase Polymaker filament, many members of our Facebook group and Discord server have had success
2. You likely will not get good results unless your printer is well maintained and calibrated, we would suggest learning how to check and adjust your printer to perform at its absolute best before starting. This website has useful guides: <https://teachingtecht.com/calibration.html#intro>.
3. **All the below guidance should be taken as a starting point only. Print a test piece** and check things like retraction settings and fitment of the carbon rods in the wings for yourself as every printer is different. If the carbon rods are too tight, increase the "Hole Horizontal Expansion" setting in Cura (or the equivalent setting in other slicers).
4. All our models are designed to be printed predominantly in LW-PLA filament. All fuselage, tail, and wing parts should be printed in LW-PLA unless otherwise noted in the file name.

There are 3 levels of infill / wall settings that we recommend for the LWPLA parts:

1. Maximum efficiency: 3% cubic subdivision, single wall
2. Balanced efficiency and strength: 5% cubic subdivision, single wall
3. Maximum strength: 8% cubic subdivision, single wall

WE RECOMMEND PRINTING MICRO TROOPER WITH 3% CUBIC SUBDIVISION INFILL

Notes:

- For the best flight characteristics and maximum range, LWPLA parts should be printed with single wall and 3% cubic subdivision infill.
- Cubic subdivision infill can be increased to 5 or 8% to increase durability, but this will have an impact on maximum payload capacity (battery), and range by extension. We recommend and use 3% cubic subdivision infill as it has been tested to survive 6.4G in flight, but some may desire greater general durability when handling/carrying the model around etc. It will still break if you crash it!
- Because the fuselage takes the most abuse during landings, some may choose to just print the fuselage sections in higher infill. Using a higher infill just for the fuselage (4%-8%) can greatly increase the longevity of the plane without as much of a weight penalty as printing the entire plane in high infill.
- Gyroid infill brings a significant weight penalty with it even at the same percentage. For the highest strength-to-weight ratio part, stick to cubic



subdivision or cubic. A part printed at 3% gyroid is comparable weight to the same part printed at 7% cubic subdivision.

Polycarbonate, PETG or other high-temp filament should be used for the motor mounts and wing bay covers.

- High temp Polycarbonate or PETG parts should be double wall and high infill (25%).

We recommend using the newest version of Ultimaker Cura. [This link](#) can be used to download our own slicer profile.

4.2: Part Orientation

It is necessary to orient each part correctly on the build plate to avoid disconnected overhangs. Take care when doing this as the entire model is designed to be printed with no supports. If you orient some parts wrong, the print will fail. It may also be necessary to rotate and carefully position some parts to fit within the build area on smaller printers.

Examples for part orientation:

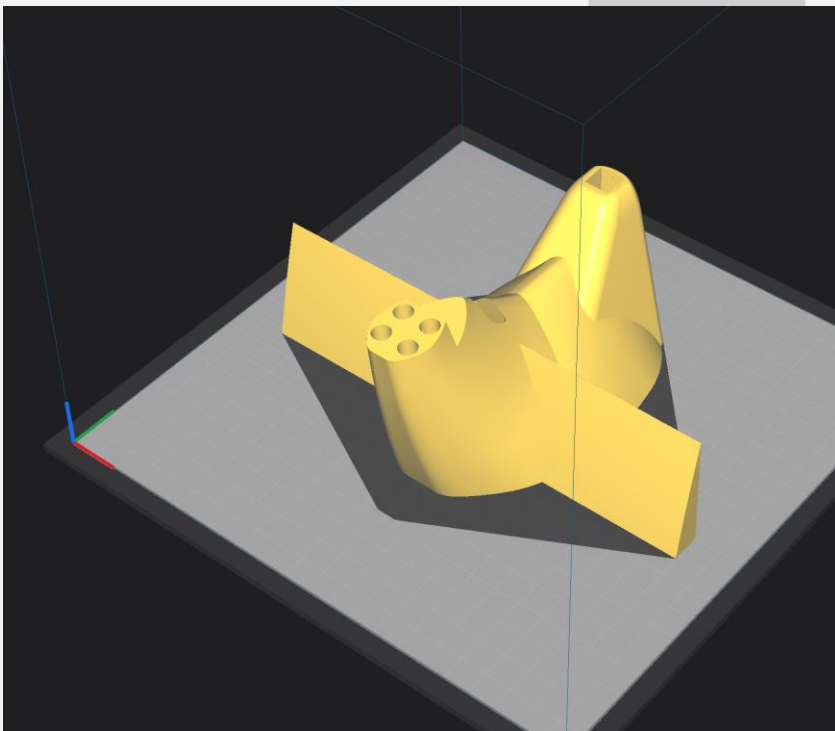



Titan Dynamics

[Titan Dynamics Webpage](#)

[Visit our Facebook page](#)

[Join our Discord server](#)

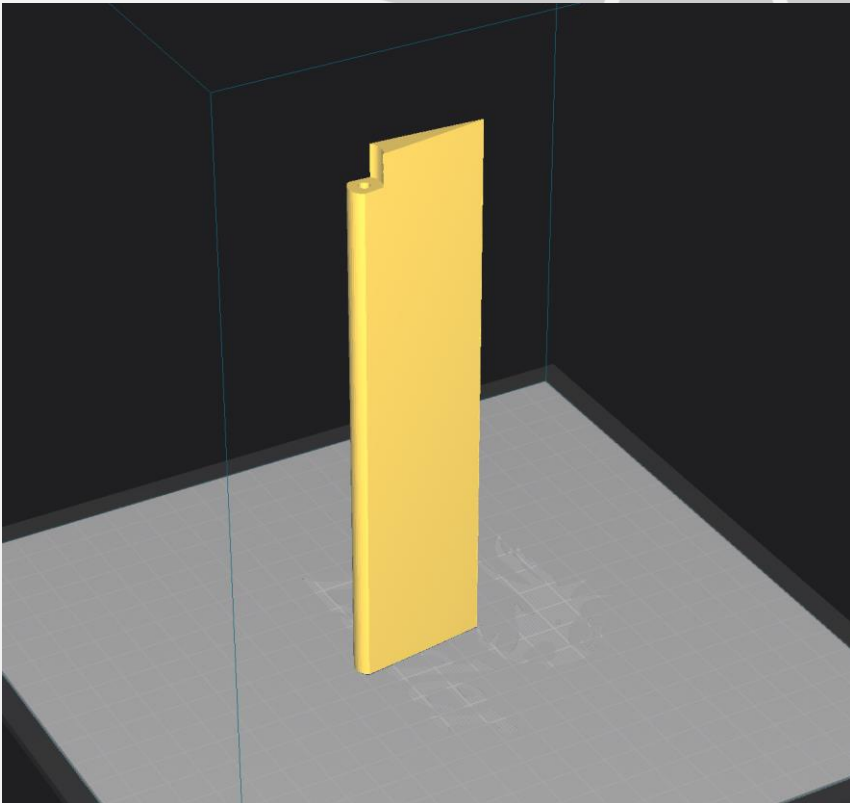
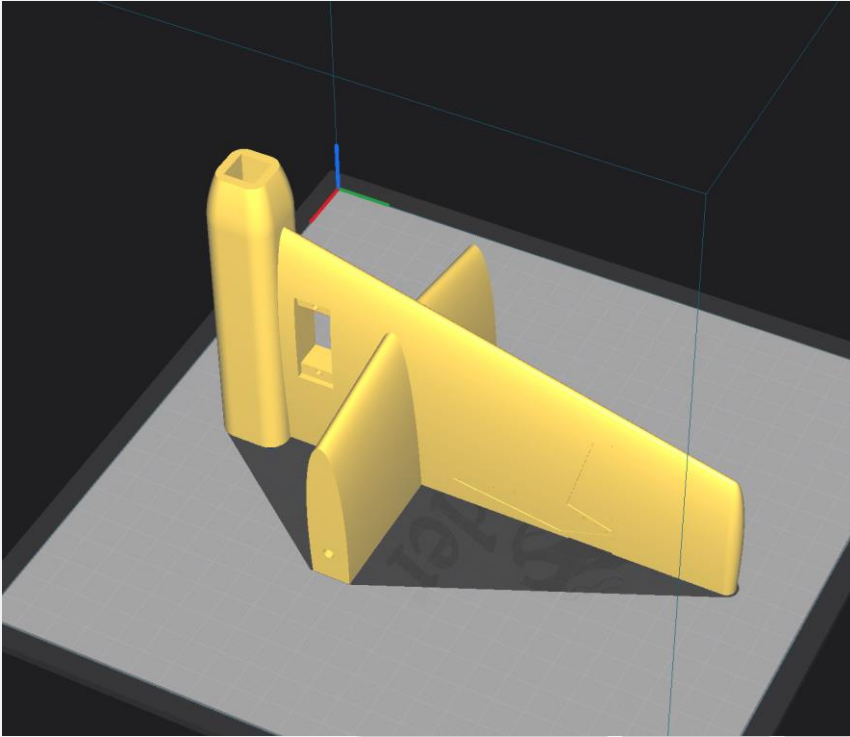



4.3: Tuning “hole horizontal expansion”

It is very important to check the fitment of the carbon rods in their holes on the first parts you print. Because everyone may be using different printers, materials and slicer settings, it is not possible to provide the models with a slicing profile and hole size that will work for everyone.

Print your first part with carbon spar hole and check fitment, if it is too tight increase the hole horizontal expansion setting in the “walls” section in Cura (or your slicer’s similar setting). A good starting point is 0.25mm. If it is too loose, just decrease the setting until you can reliably push the rods in and still get a snug fit.

4.4: Bed Adhesion and warping

When printing tall parts like this and other models require, having good print adhesion to the bed is a necessity. Ideally you will print each part without any extra aids, however this may not be possible for many, especially those printing without an enclosure for their printer. A full brim can be used but this will typically have mixed results. If it works for you, use a glue stick on the print surface to improve adhesion. Cura also has a plugin that can be used to help with bed adhesion and to avoid warping.

Cura Marketplace: TabAntiWarping Plugin.

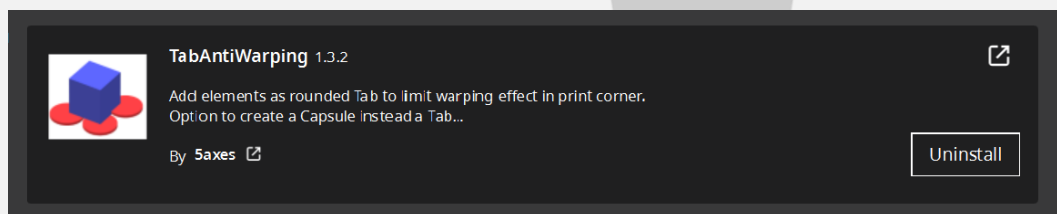

When installed, use the new icon at the bottom of the left menu to choose tab diameter and thickness, then click on the model to add a tab at each point you think is at risk of warping or poor adhesion (typically parts with low surface area in contact with the print surface in relation to their height). These new tabs can now be moved around to fine tune their position using the normal move controls on Cura.

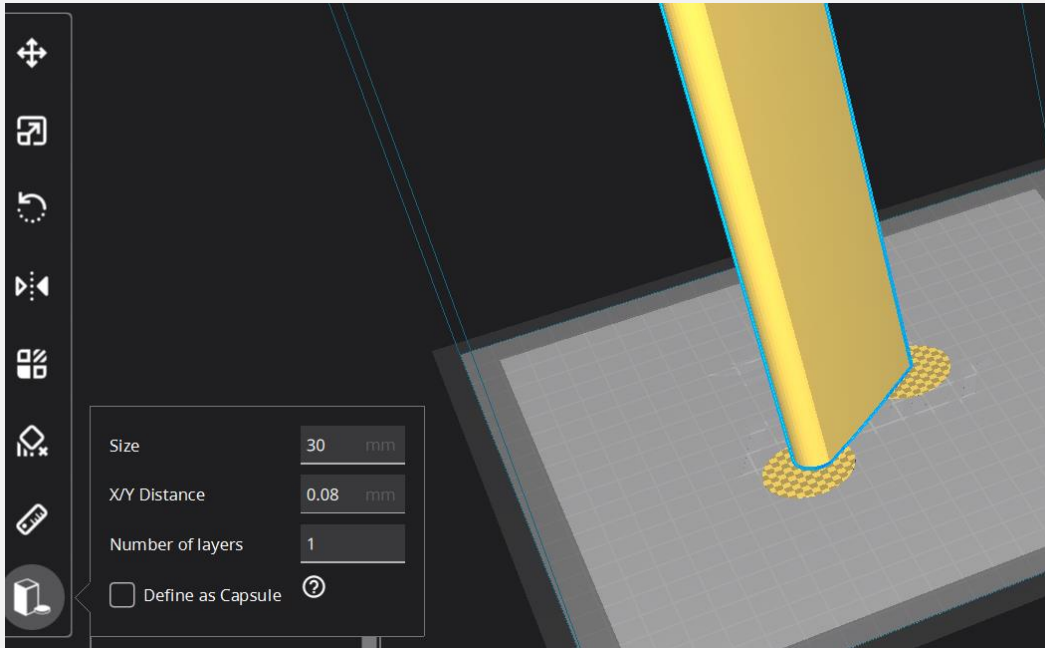

Once completed, be careful when removing these tabs from the print as they are quite strong and can damage the bottom of your part if not removed carefully. Re-open any holes the tab may have filled on the bottom of the print.

If you find these hard to remove from the print bed, select the “Define as Capsule” option. This makes the edge of the tabs raised, so you can get a scraper underneath them.



Section 5: Assembly of 3D Printed Parts

Below are a few exploded views of the *Micro Trooper* to help with assembly.

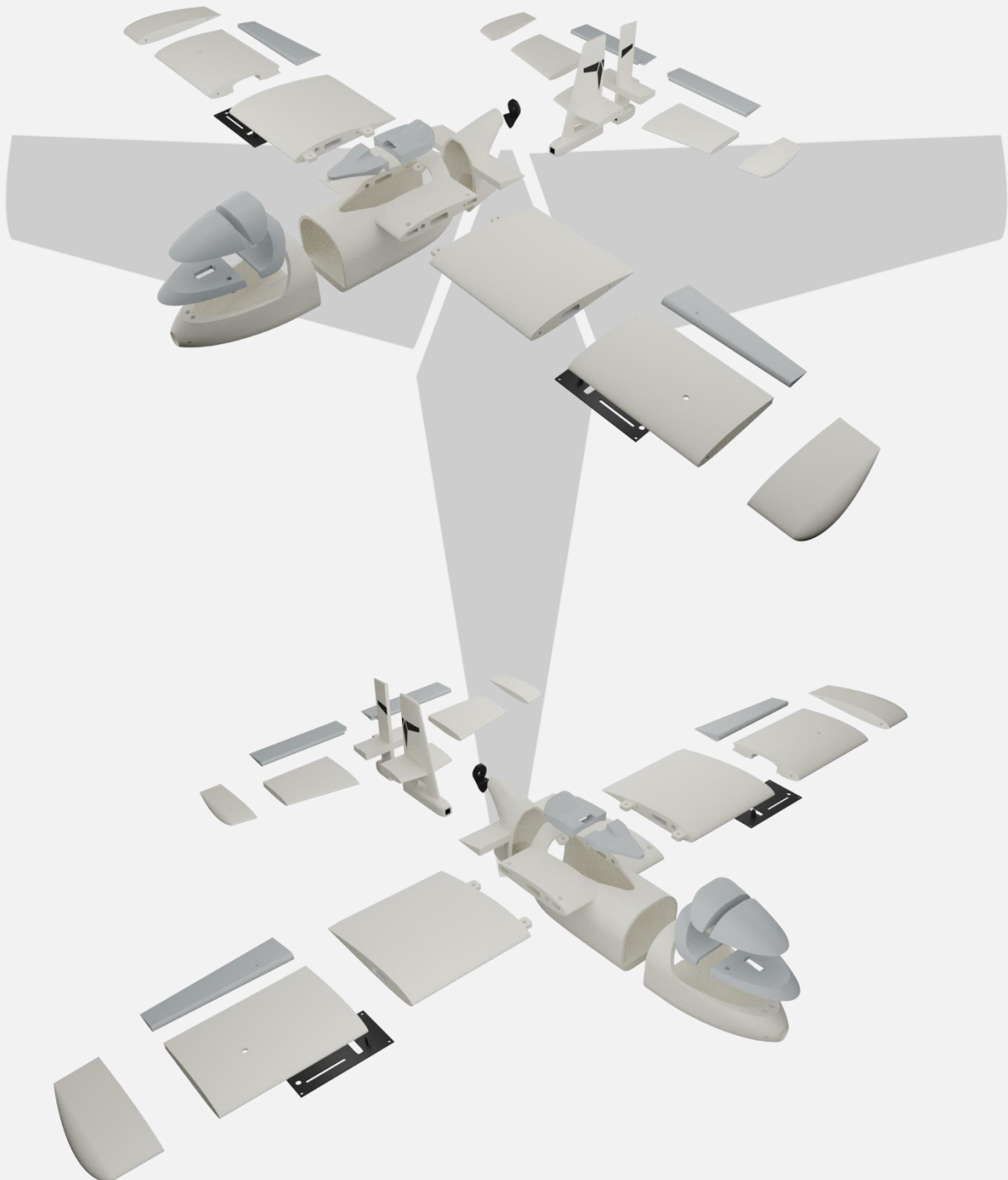



Titan Dynamics

[Titan Dynamics Webpage](#)

[Visit our Facebook page](#)

[Join our Discord server](#)

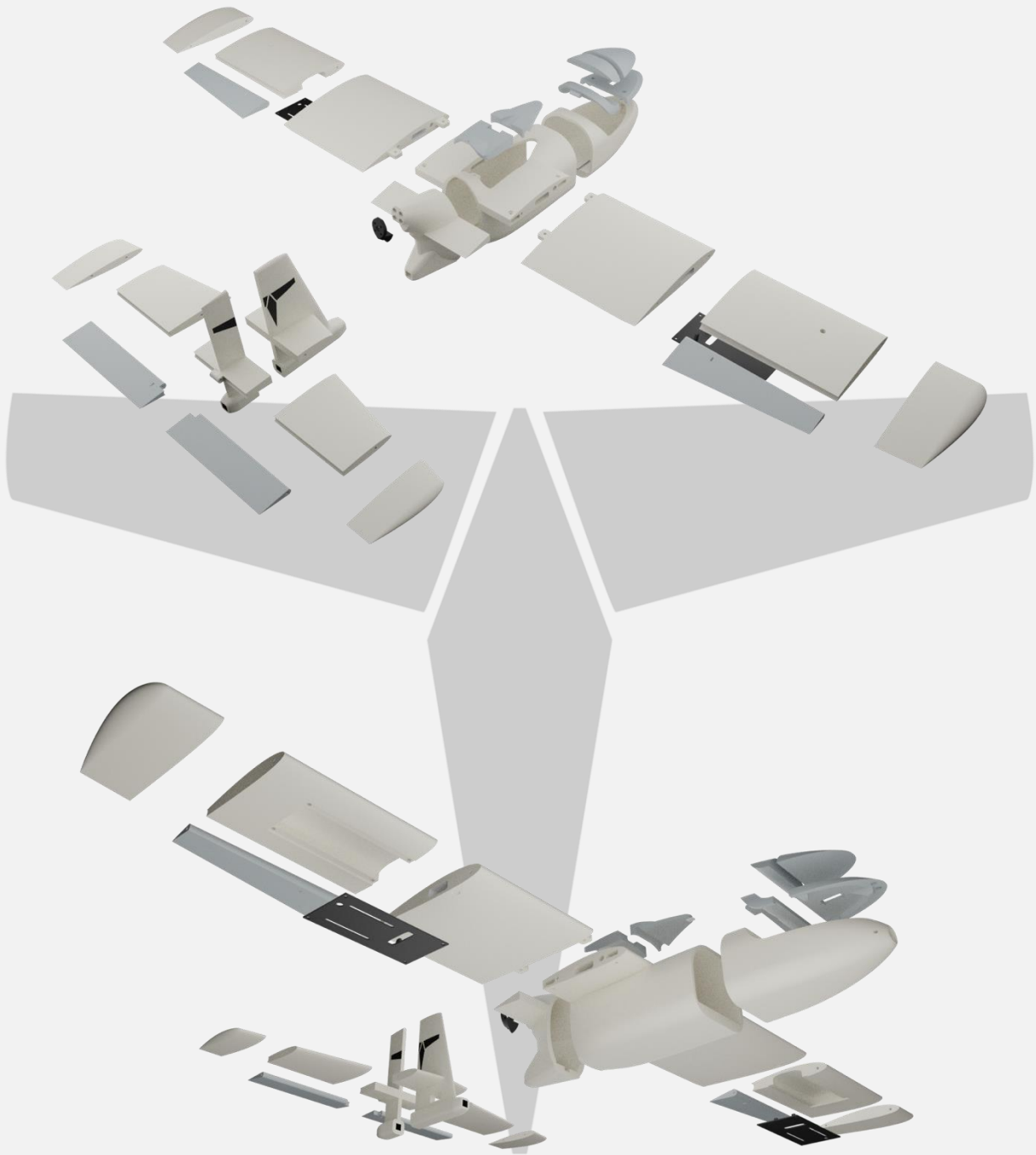



Titan Dynamics

[Titan Dynamics Webpage](#)

[Visit our Facebook page](#)

[Join our Discord server](#)

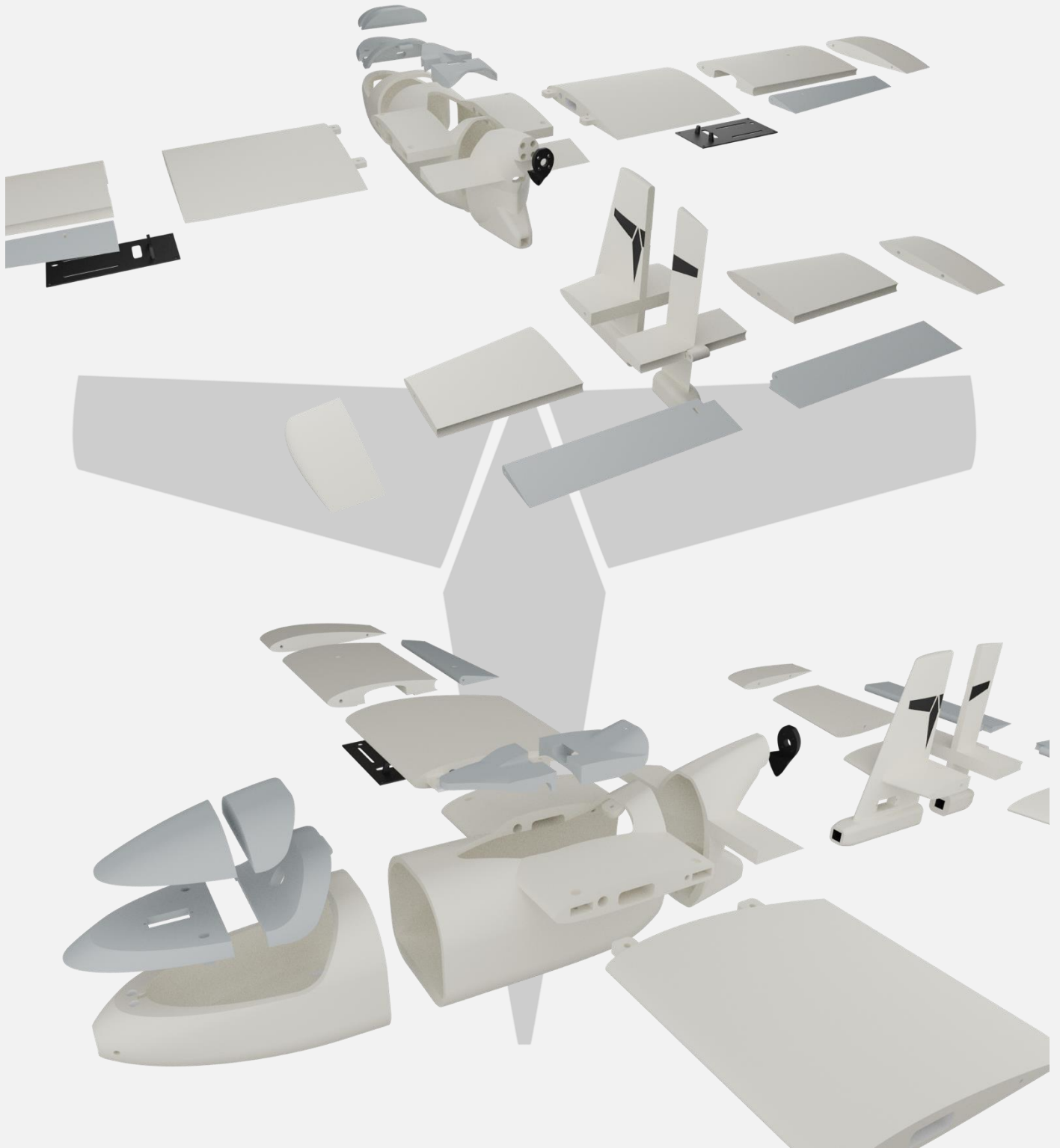



The spar layout for Micro Trooper is as depicted below. None of the spars need to be glued in (**EXCEPT FOR THE TAIL BOOM**), they will all be retained by the printed parts. The two wing spars that intersect the fuselage are the joiners for the wings and the fuselage and can be removed completely from the fuselage and wing during transport.

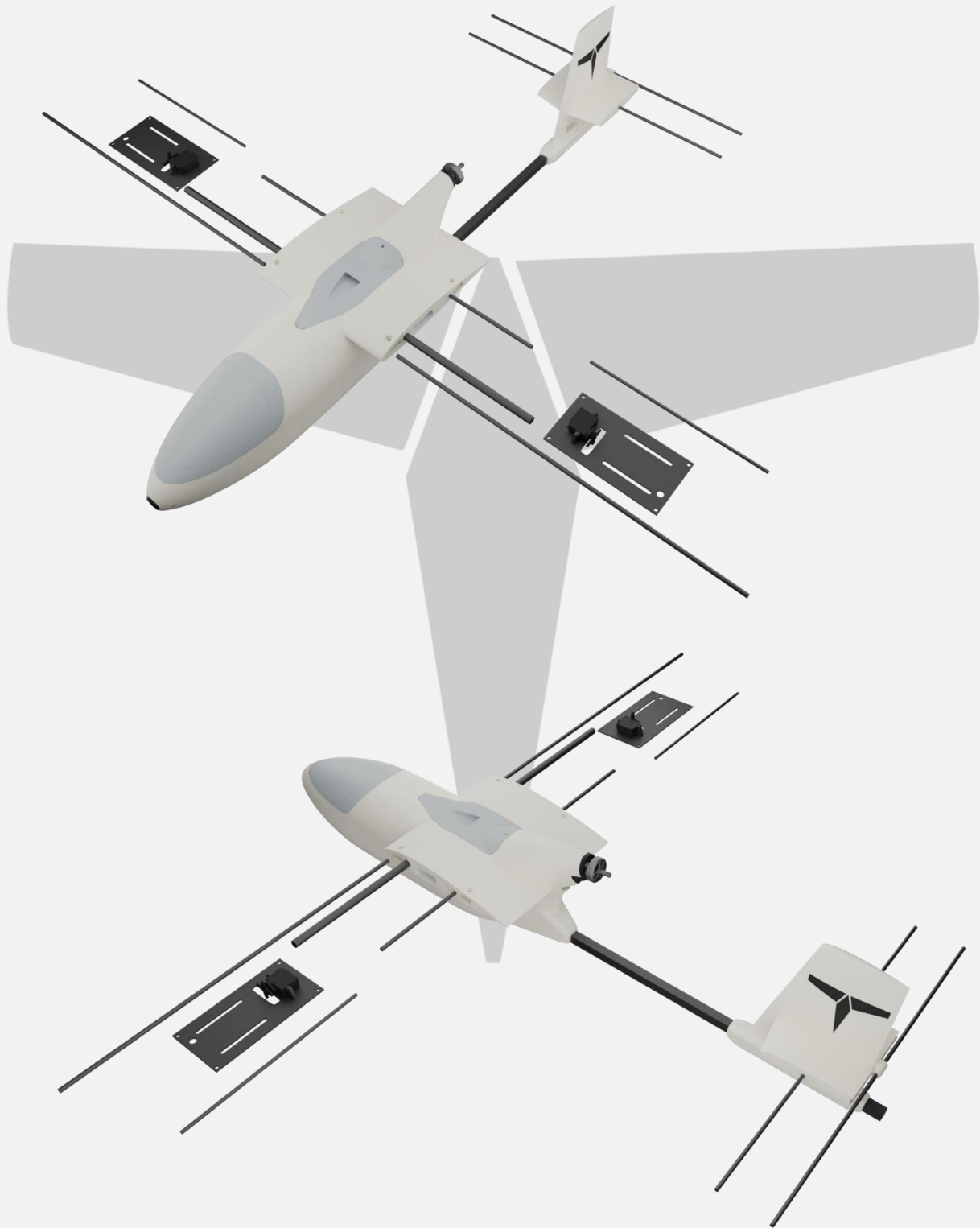

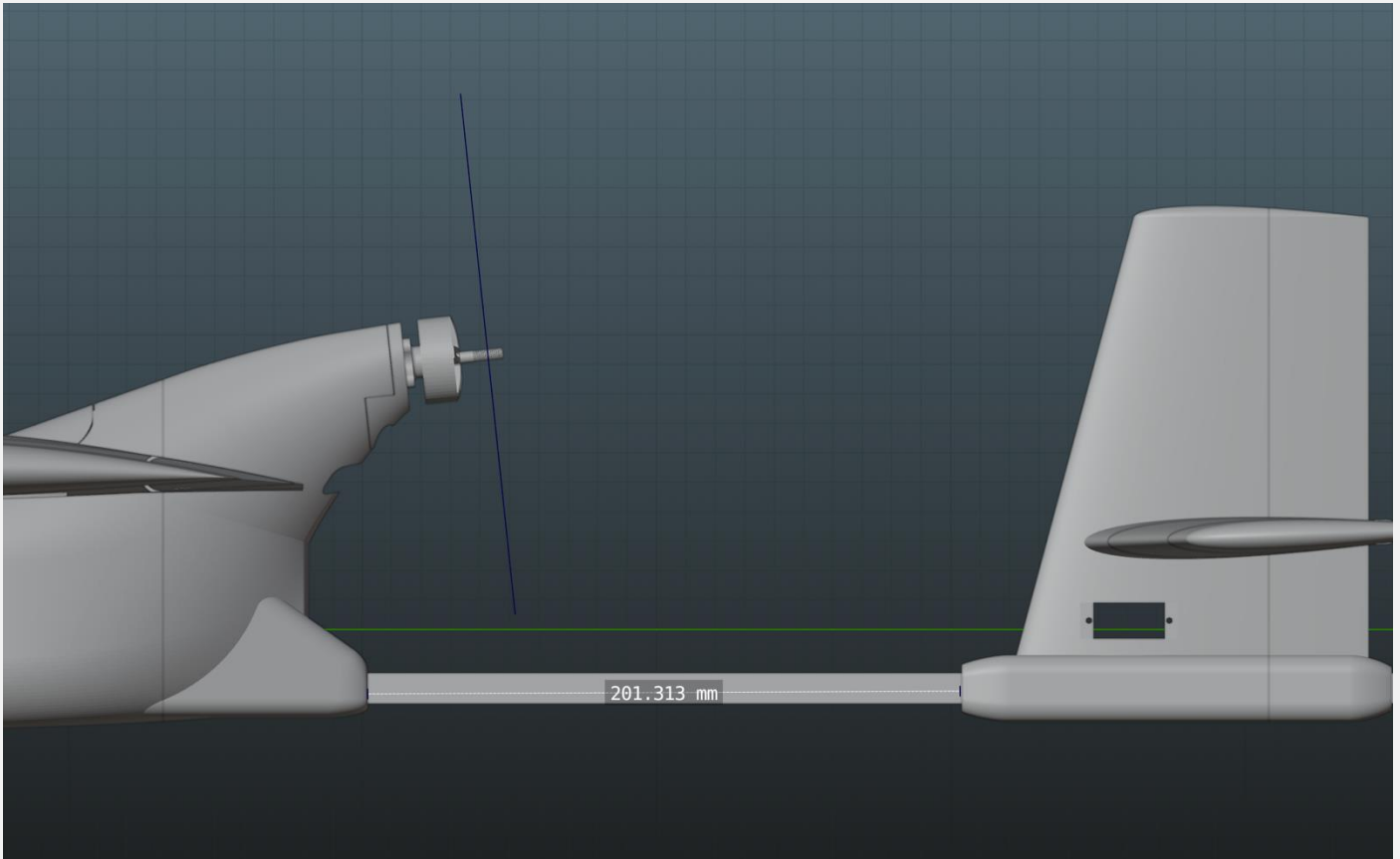

Please make sure the tail boom's exposed length is ~200mm. Feel free to adjust based on CG or desired stability (farther away = more stable, closer = more acrobatic). Stay within +/- 20mm of the recommended distance.

- Medium CA glue should be used to assemble all fuselage parts.
- When first putting the glued parts together be sure to wipe any excess glue off before it sets. A kicker may then be used to speed up the setting time; technically this results in a weaker joint, however it will still be stronger than the base material LW-PLA.
- Use care when aligning parts for gluing. With medium CA, you should have a few seconds to get alignment right. Small mistakes in alignment can stack up and eventually lead to a part not fitting perfectly. We have taken care when designing the aircraft to make sure there is tolerance for some minor mistakes but try to be as perfect as possible when gluing.
- When gluing the wings together, use the carbon rods to ensure alignment however be careful not to glue them in, they should not be glued in on the final product.
- **IMPORTANT!** - Do not glue the wing tips on until you have the carbon rod and aileron/flap installed as it's the wing tip that secures these in place. If you glue the wing tip on before inserting the control surfaces + carbon rod you will not be able to insert them afterwards.
- Threaded inserts can be properly installed by using a soldering iron at low heat setting, a good guide for doing this can be found at [this link](#).



Section 6: Final Setup & Tuning Tips

- Titan Dynamics strongly recommends the use of Arduplane for all our models. If you encounter an issue in flight, the data logs Ardupilot creates are invaluable for finding the root cause of any issue and increasing future chances of success.
- Give all control surfaces +/- 30 degrees or more throw.
- Take-off does not require flaps, but landing can be done easier with half flaps.
- CG is marked under the wing and should be kept very close to that point.
- Add duct tape or other abrasion resistant material to bottom of the fuselage to increase durability if landing on rough surfaces.





Titan Dynamics

[Titan Dynamics Webpage](#)

[Visit our Facebook page](#)

[Join our Discord server](#)

Section 7: Additional Images

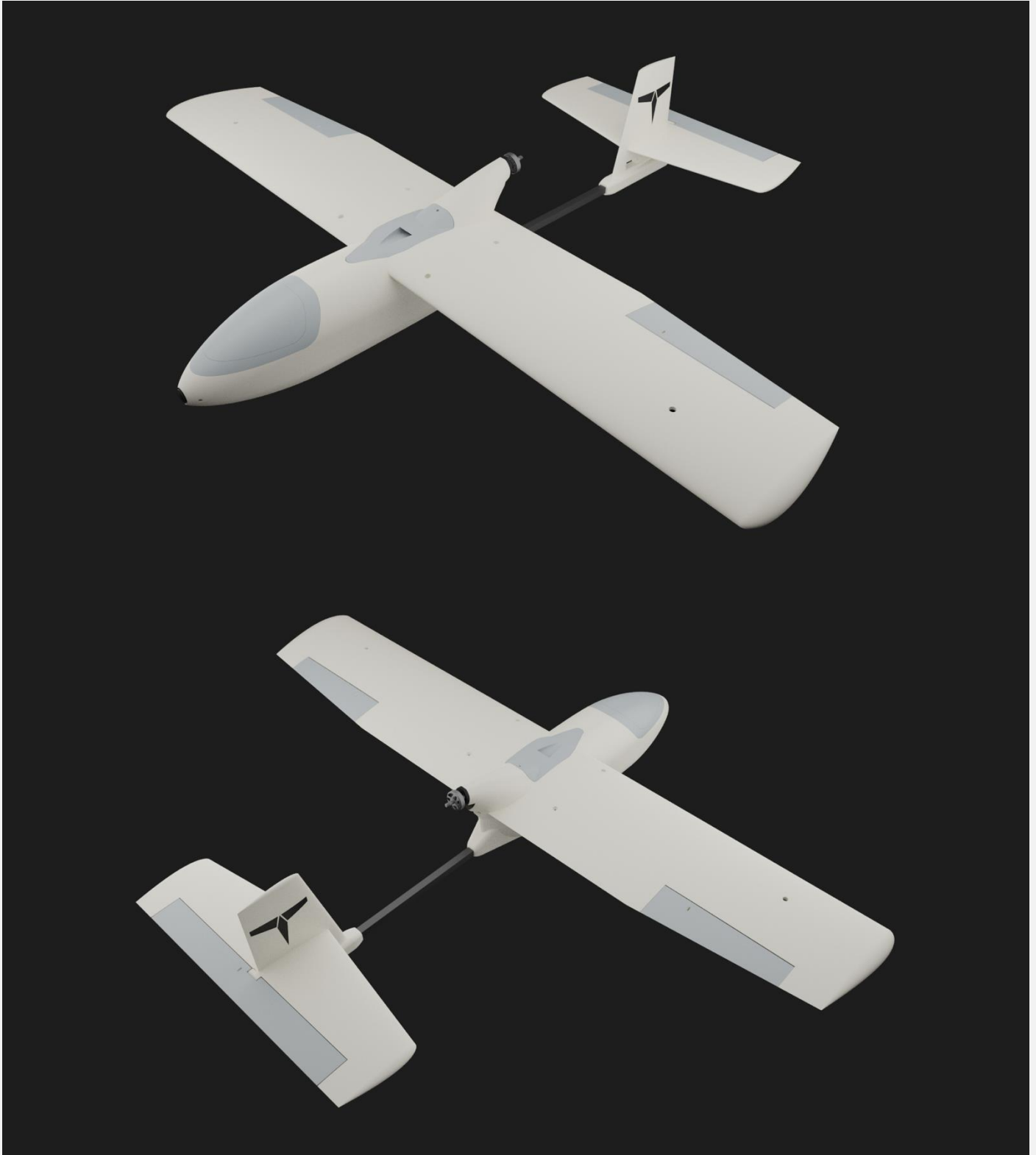



Titan Dynamics

[Titan Dynamics Webpage](#)

[Visit our Facebook page](#)

[Join our Discord server](#)

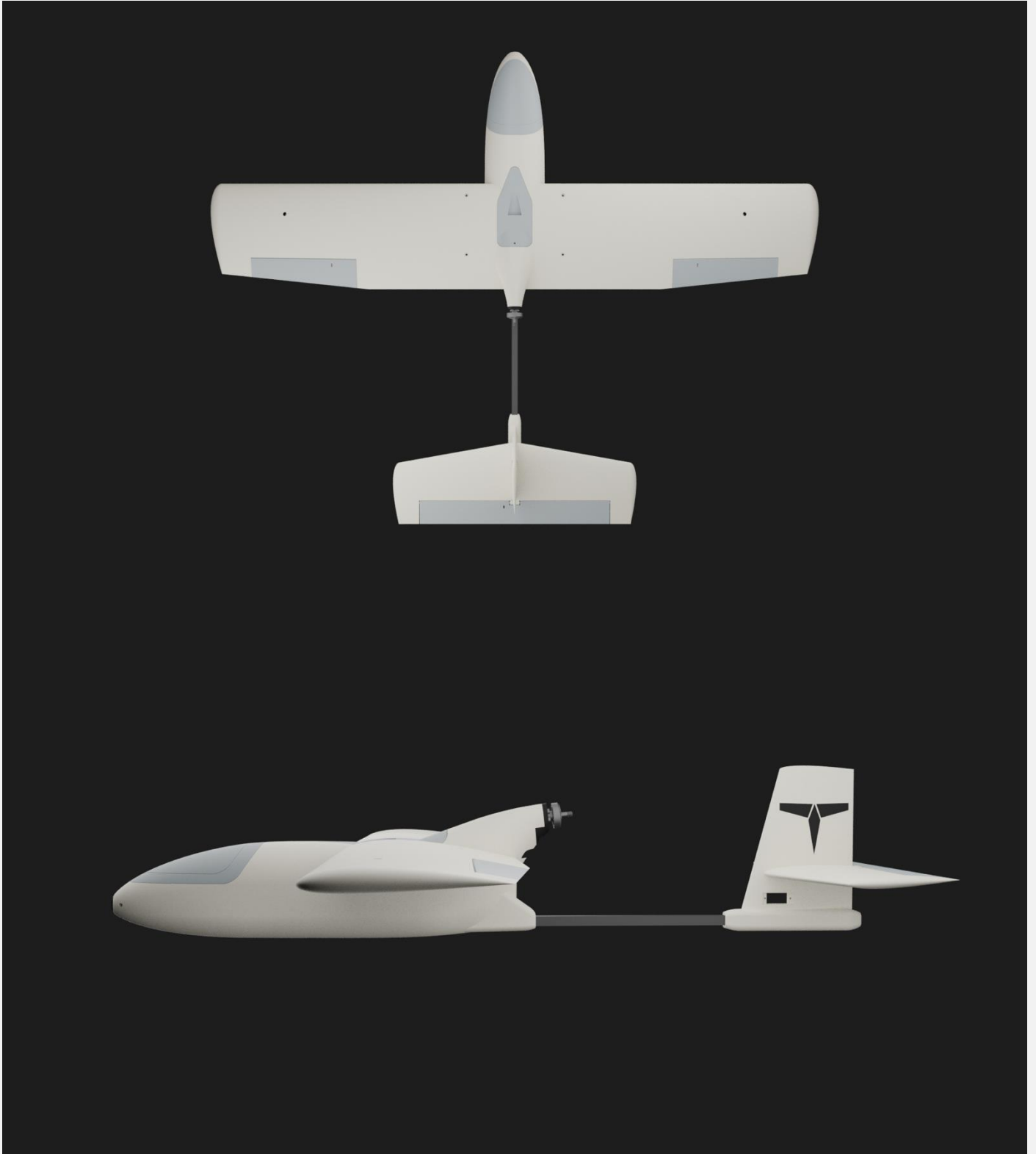



Titan Dynamics

[Titan Dynamics Webpage](#)

[Visit our Facebook page](#)

[Join our Discord server](#)

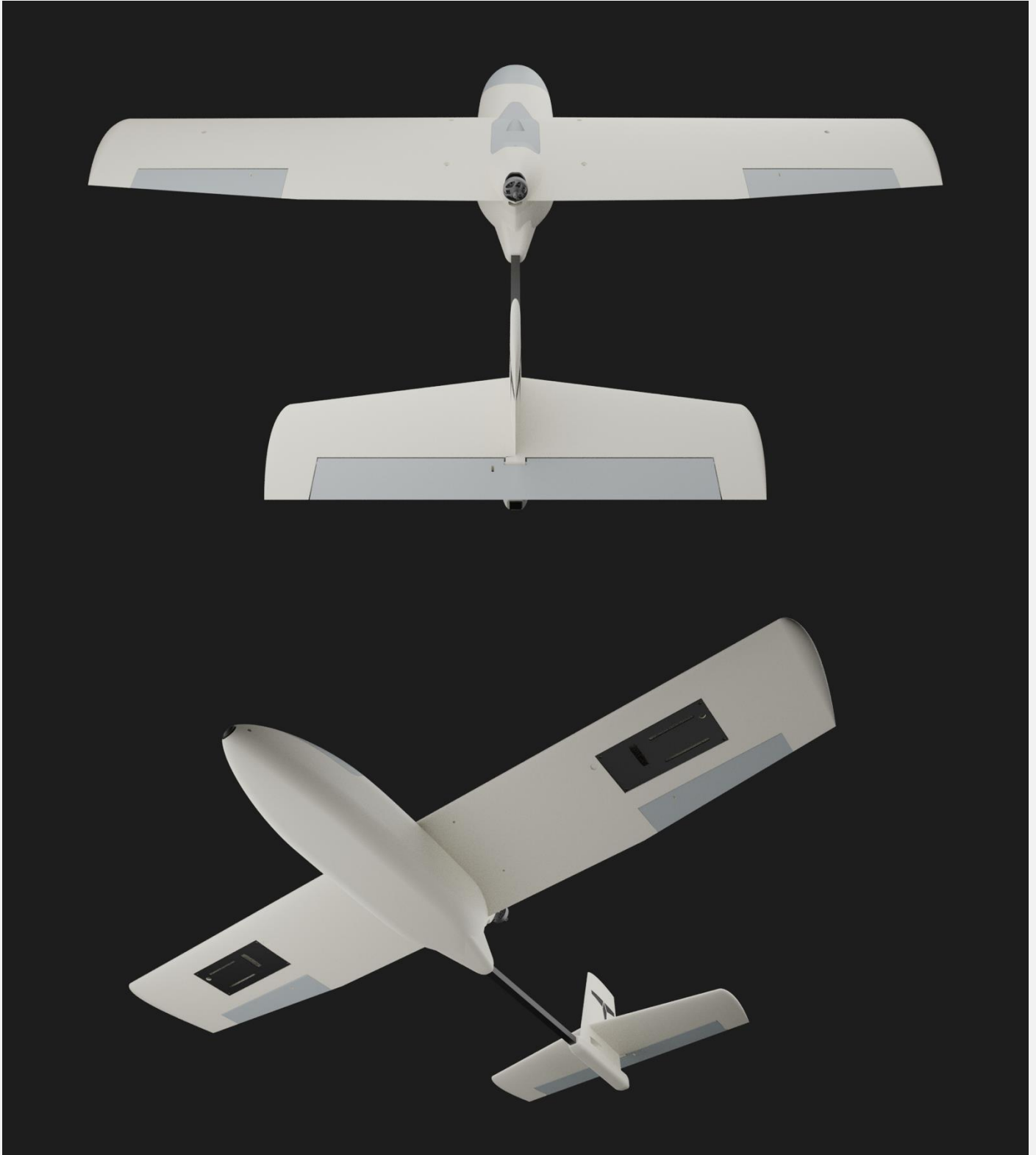



Titan Dynamics

[Titan Dynamics Webpage](#)

[Visit our Facebook page](#)

[Join our Discord server](#)

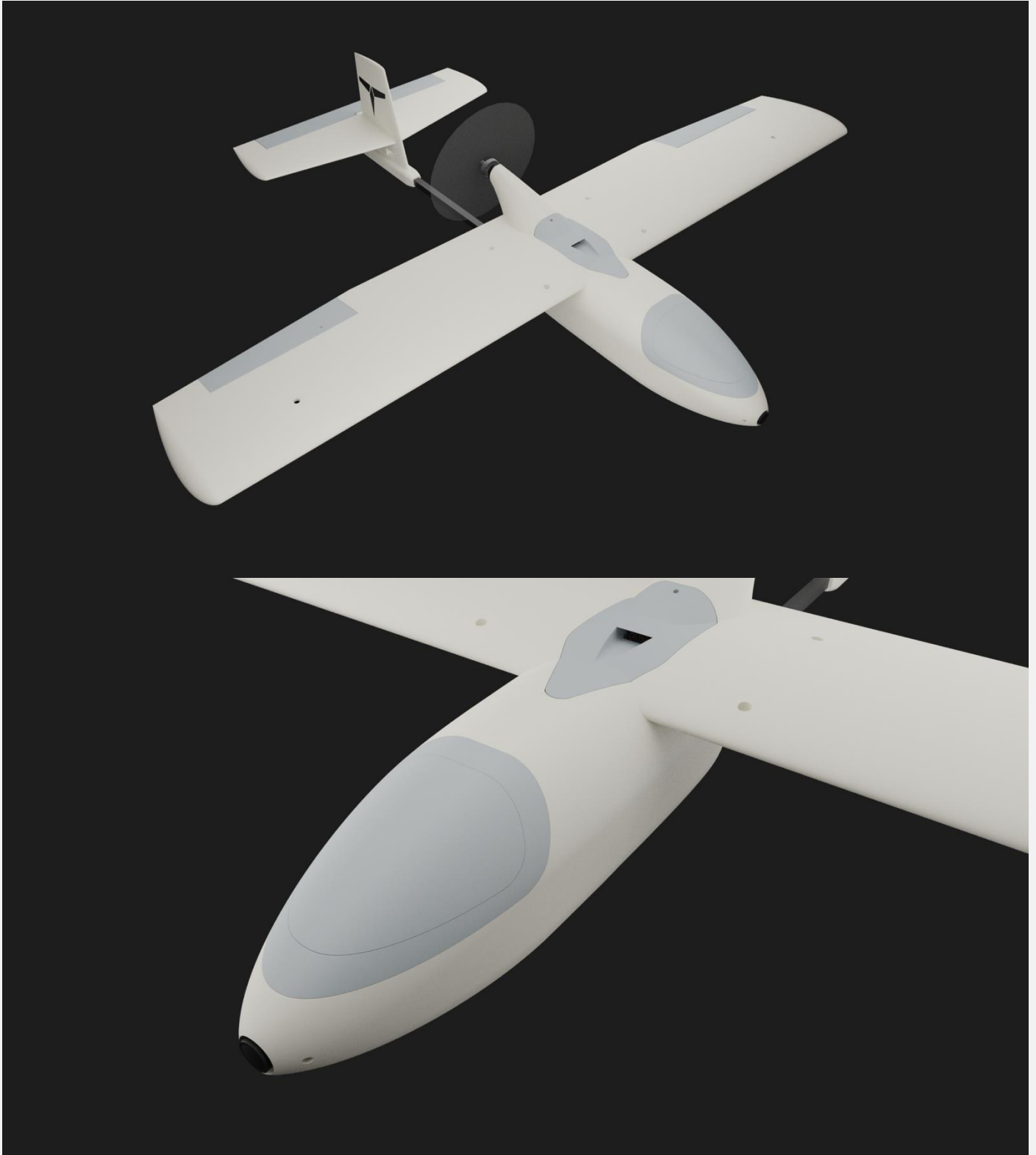

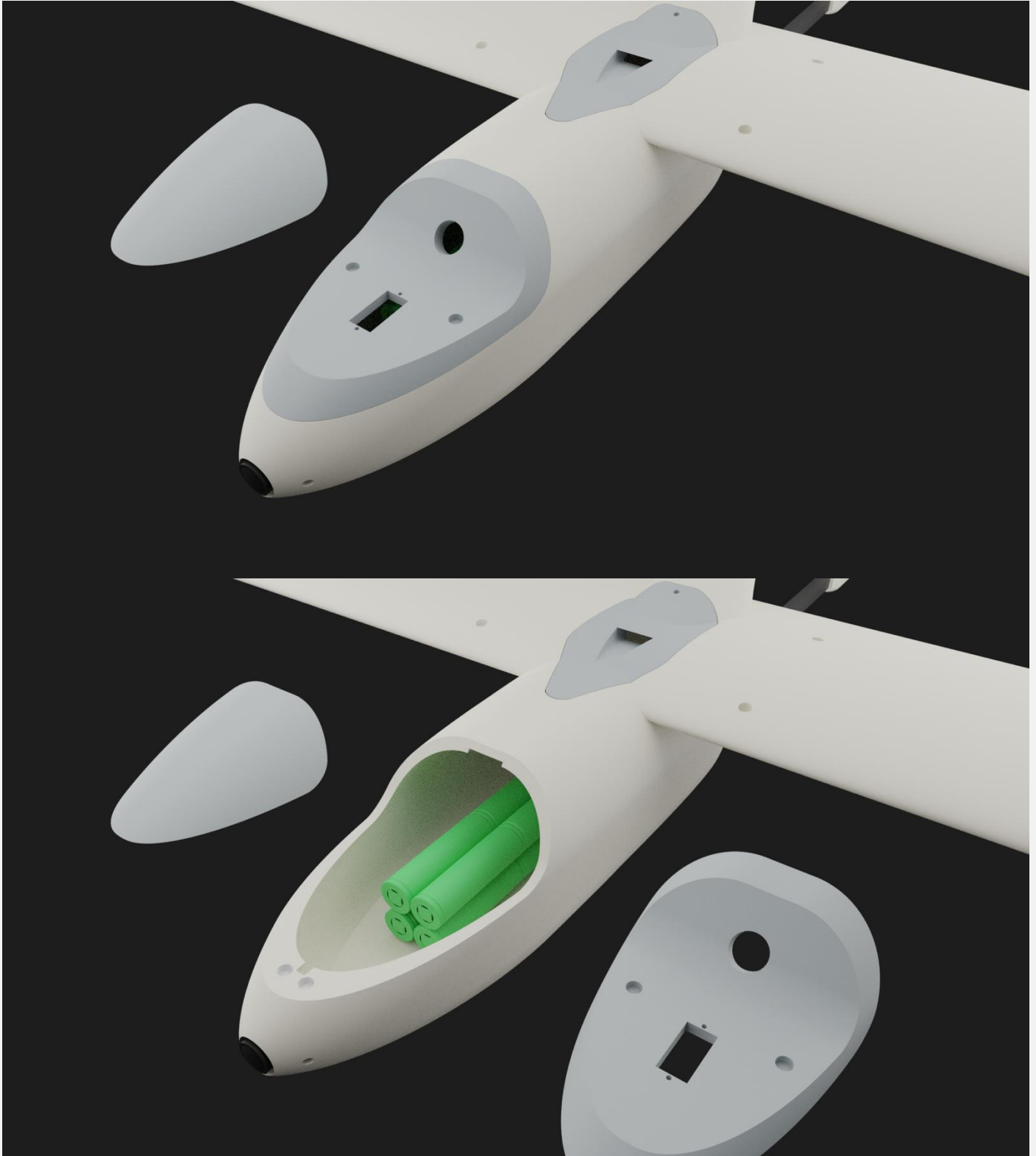



Titan Dynamics

[Titan Dynamics Webpage](#)

[Visit our Facebook page](#)

[Join our Discord server](#)

